

W360 Animal Health UVA / UVB Light

30W LED / 35°



- Broadband UVA for Animal Health
- UVB for Reptile Vitamin D3 Synthesis
- Adjustable Intensity
- DMX Controllable
- Also Available with Other Optics

ORDERING GUIDE

CXW360N - **UVBA** - - - -

Spectrum

UVBA UVBA

Finish

WH White
BK Black

Mount

TOX w/ O-type DMX Track Adapter
TON w/ O-type Non-DMX Track Adapter
CLP w/ Clamp Mount
MPT w/ Monopoint Adapter Mount (PSX+120V only)

Power Supply & Control

PS Power Supply



PSX Power Supply w/ DMX
(compatible with TOX/MPT mount)



Plug/Connection

US US 120V
EU EU 220V

SPECIFICATIONS

Beam Angle	35°
Spectrum Type	UVBA
Control	Intensity (0% - 100%)
LED Source	DiCon Dense Matrix LED
AC Power Draw	30W max
AC Input Voltage	100 - 240V AC, 60Hz
Cooling	Fan Cooled
Operating Temperature	32 - 104°F (0 - 40°C)
Fixture Weight	1.1lb (0.5kg)
Power Supply Weight	1.0lb (0.4kg)

MECHANICAL FIGURES

W360N-TOX/TON

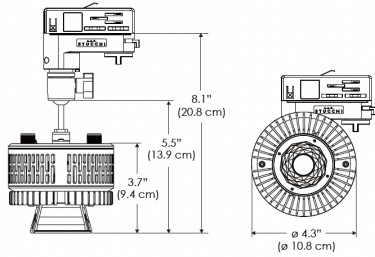

PS US

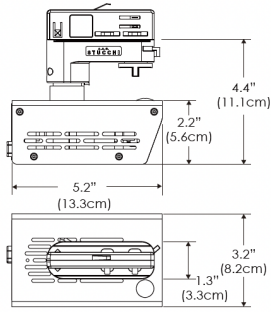

PSX US

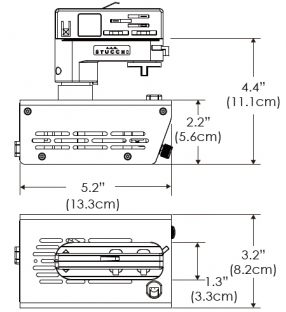

W360N-TOX/TON

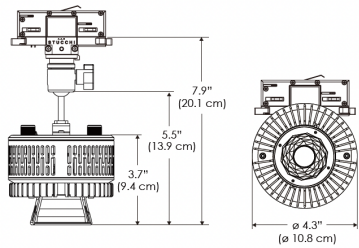

PS EU

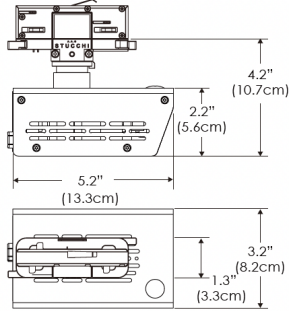

PSX EU

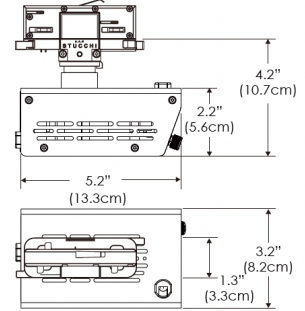

W360N-CLP

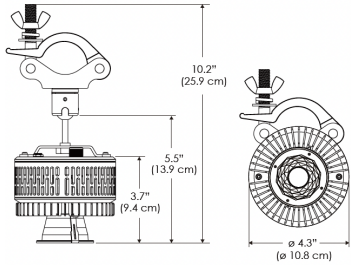

PS US EU

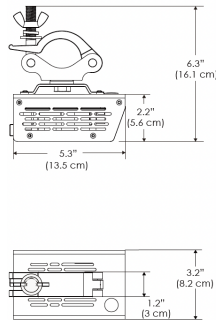

Mounting Bracket Dimensions ALL-CLP

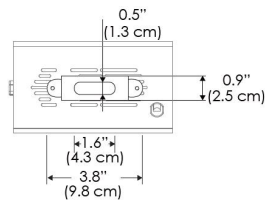

*All -CLP configuration models come with standard DC cables of 6" and AC cables of 10'.

W360N-MPT

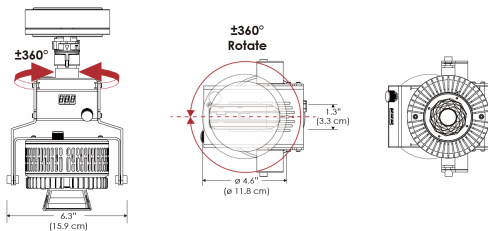

PSX US

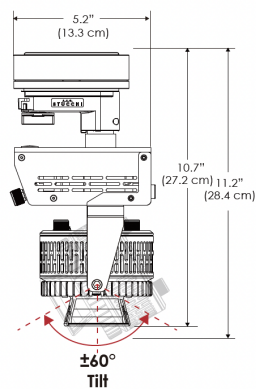

PSX EU

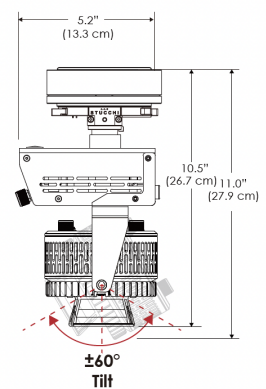

PHOTOMETRIC DATA

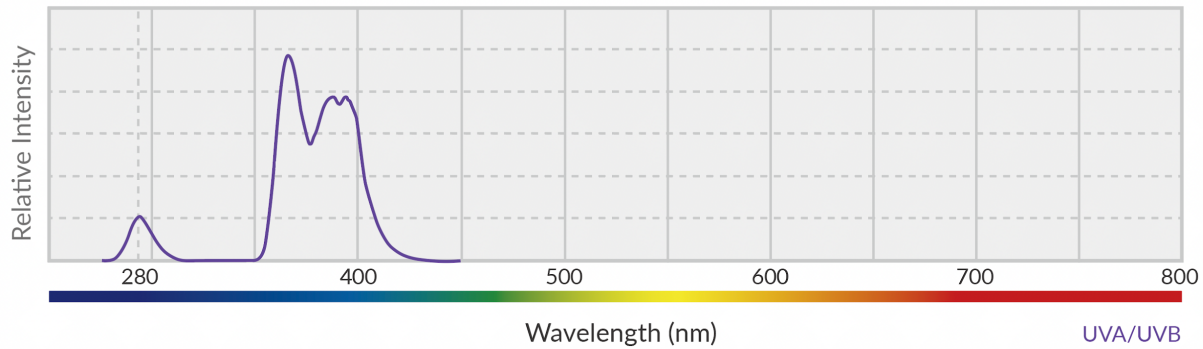

Distance		1' (~0.3 m)	3' (~0.9 m)	5' (~1.5 m)
Total UV	μw/cm ²	9870	882	300
UVA		9107	813	279
UVB		763	69	20
Beam Diameter		Ø 1.1' (0.3m)	Ø 3.1' (0.9m)	Ø 4.9' (1.5m)